

Low voltage LNA and mixer - 1GHz

SA601

DESCRIPTION

The SA601 is a combined RF amplifier and mixer designed for high-performance low-power communication systems from 800-1200MHz. The low-noise preamplifier has a 1.6dB noise figure at 900MHz with 11.5dB gain and an IP3 intercept of -2dBm at the input. The gain is stabilized by on-chip compensation to vary less than ± 0.2 dB over -40 to +85°C temperature range. The wide-dynamic-range mixer has a 9.5dB noise figure and IP3 of -2dBm at the input at 900MHz. The nominal current drawn from a single 3V supply is 7.4mA. The Mixer can be powered down to further reduce the supply current to 4.4mA.

FEATURES

- Low current consumption: 7.4mA nominal, 4.4mA with the mixer powered-down
- Outstanding LNA noise figure: 1.6dB at 900MHz
- High system power gain: 18dB (LNA + Mixer) at 900MHz
- Excellent gain stability versus temperature and supply voltage
- External >-7dBm LO can be used to drive the mixer

PIN CONFIGURATION

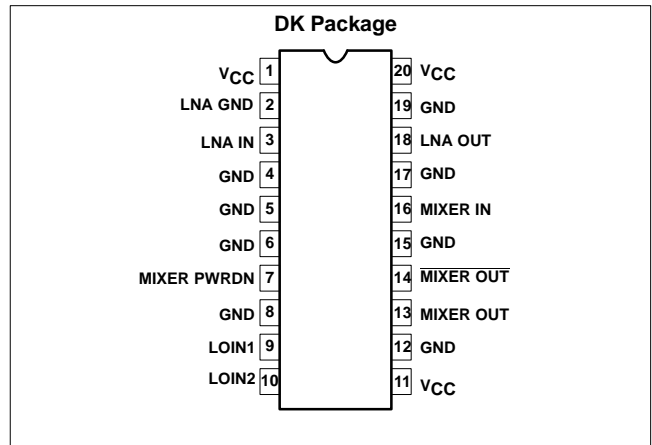

APPLICATIONS

- 900MHz cellular front-end (NADC, GSM, AMPS, TACS)
- 900MHz cordless front-end (CT1, CT2)
- 900MHz receivers

ORDERING INFORMATION

DESCRIPTION	TEMPERATURE RANGE	ORDER CODE	DWG #
20-Pin Plastic Shrink Small Outline Package (Surface-mount, SSOP)	-40 to +85°C	SA601DK	1563

BLOCK DIAGRAM

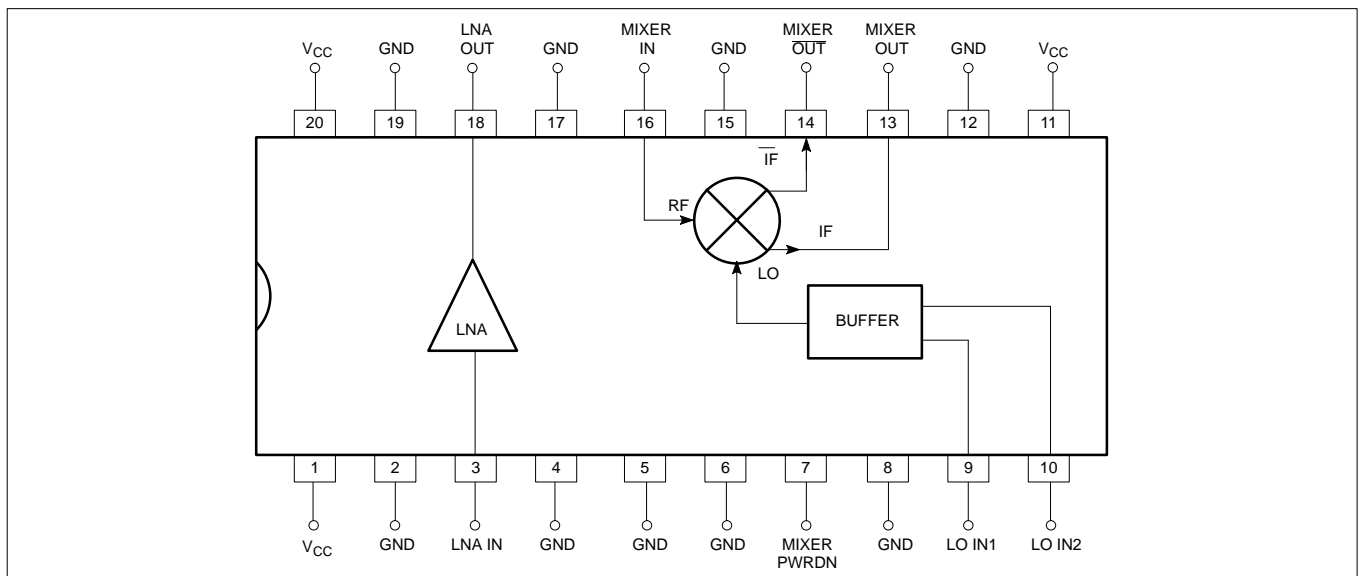

Low voltage LNA and mixer - 1GHz

SA601

ABSOLUTE MAXIMUM RATINGS³

SYMBOL	PARAMETER	RATING	UNITS
V_{CC}	Supply voltage ¹	-0.3 to +6	V
V_{IN}	Voltage applied to any other pin	-0.3 to ($V_{CC} + 0.3$)	V
P_D	Power dissipation, $T_A = 25^\circ\text{C}$ (still air) ² 20-Pin Plastic SSOP	980	mW
T_{JMAX}	Maximum operating junction temperature	150	$^\circ\text{C}$
P_{MAX}	Maximum power input/output	+20	dBm
T_{STG}	Storage temperature range	-65 to +150	$^\circ\text{C}$

NOTE:

- Transients exceeding 8V on V_{CC} pin may damage product.
- Maximum dissipation is determined by the operating ambient temperature and the thermal resistance,
 θ_{JA} : 20-Pin SSOP = 110°C/W
- Pins 9 and 10 are sensitive to electrostatic discharge (ESD).

RECOMMENDED OPERATING CONDITIONS

SYMBOL	PARAMETER	RATING	UNITS
V_{CC}	Supply voltage	2.7 to 5.5	V
T_A	Operating ambient temperature range	-40 to +85	$^\circ\text{C}$
T_J	Operating junction temperature	-40 to +105	$^\circ\text{C}$

DC ELECTRICAL CHARACTERISTICS $V_{CC} = +3\text{V}$, $T_A = 25^\circ\text{C}$; unless otherwise stated.

SYMBOL	PARAMETER	TEST CONDITIONS	LIMITS			UNITS
			MIN	TYP	MAX	
I_{CC}	Supply current			7.4		mA
		Mixer power-down input low		4.4		
V_{LNA-IN}	LNA input bias voltage			0.78		V
$V_{LNA-OUT}$	LNA output bias voltage			2.1		V
V_{MX-IN}	Mixer RF input bias voltage			0.94		V

Low voltage LNA and mixer - 1GHz

SA601

AC ELECTRICAL CHARACTERISTICS $V_{CC} = +3V$, $T_A = 25^{\circ}C$; $LO_{IN} = -7dBm$ @ 964MHz; unless otherwise stated.

SYMBOL	PARAMETER	TEST CONDITIONS	LIMITS			UNITS
			-3 σ	TYP	+3 σ	
S_{21}	Amplifier gain	881MHz	10	11.5	13	dB
$\Delta S_{21}/\Delta T$	Gain temperature sensitivity	881MHz		0.003		dB/ $^{\circ}C$
$\Delta S_{21}/\Delta f$	Gain frequency variation	800MHz - 1.2GHz		0.01		dB/MHz
S_{12}	Amplifier reverse isolation	881MHz		-20		dB
S_{11}	Amplifier input match ¹	881MHz		-10		dB
S_{22}	Amplifier output match ¹	881MHz		-10		dB
P_{-1dB}	Amplifier input 1dB gain compression	881MHz		-16		dBm
IP3	Amplifier input third order intercept	$f_2 - f_1 = 25kHz$, 881MHz	-3.5	-2	-0.5	dBm
NF	Amplifier noise figure	881MHz	1.3	1.6	1.9	dB
V_{GC}	Mixer voltage conversion gain: $R_P = R_L = 1k\Omega$	$f_S = 881MHz$, $f_{LO} = 964MHz$, $f_{IF} = 83MHz$	18.0	19.5	21.0	dB
P_{GC}	Mixer power conversion gain: $R_P = R_L = 1k\Omega$	$f_S = 881MHz$, $f_{LO} = 964MHz$, $f_{IF} = 83MHz$	5.0	6.5	8.0	dB
S_{11M}	Mixer input match ¹	881MHz		-10		dB
NF_M	Mixer SSB noise figure	881MHz	8.0	9.5	11.0	dB
P_{-1dB}	Mixer input 1dB gain compression	881MHz		-13		dBm
IP3M	Mixer input third order intercept	$f_2 - f_1 = 25kHz$, 881MHz	-3.5	-2	-0.5	dBm
IP2INT	Mixer input second order intercept	881MHz		12		dBm
P_{RFM-IF}	Mixer RF feedthrough	881MHz		-7		dB
P_{LO-IF}	LO feedthrough to IF	881MHz		-25		dB
P_{LO-RFM}	LO to mixer input feedthrough	881MHz		-38		dB
P_{LO-RF}	LO to LNA input feedthrough	881MHz		-40		dB
$P_{LNA-RFM}$	LNA output to mixer input	881MHz		-40		dB
P_{RFM-LO}	Mixer input to LO feedthrough	881MHz		-23		dB
LO_{IN}	LO drive level	964MHz		-7		dBm

NOTE:

1. Simple L/C elements are needed to achieve specified return loss.

Low voltage LNA and mixer - 1GHz

SA601

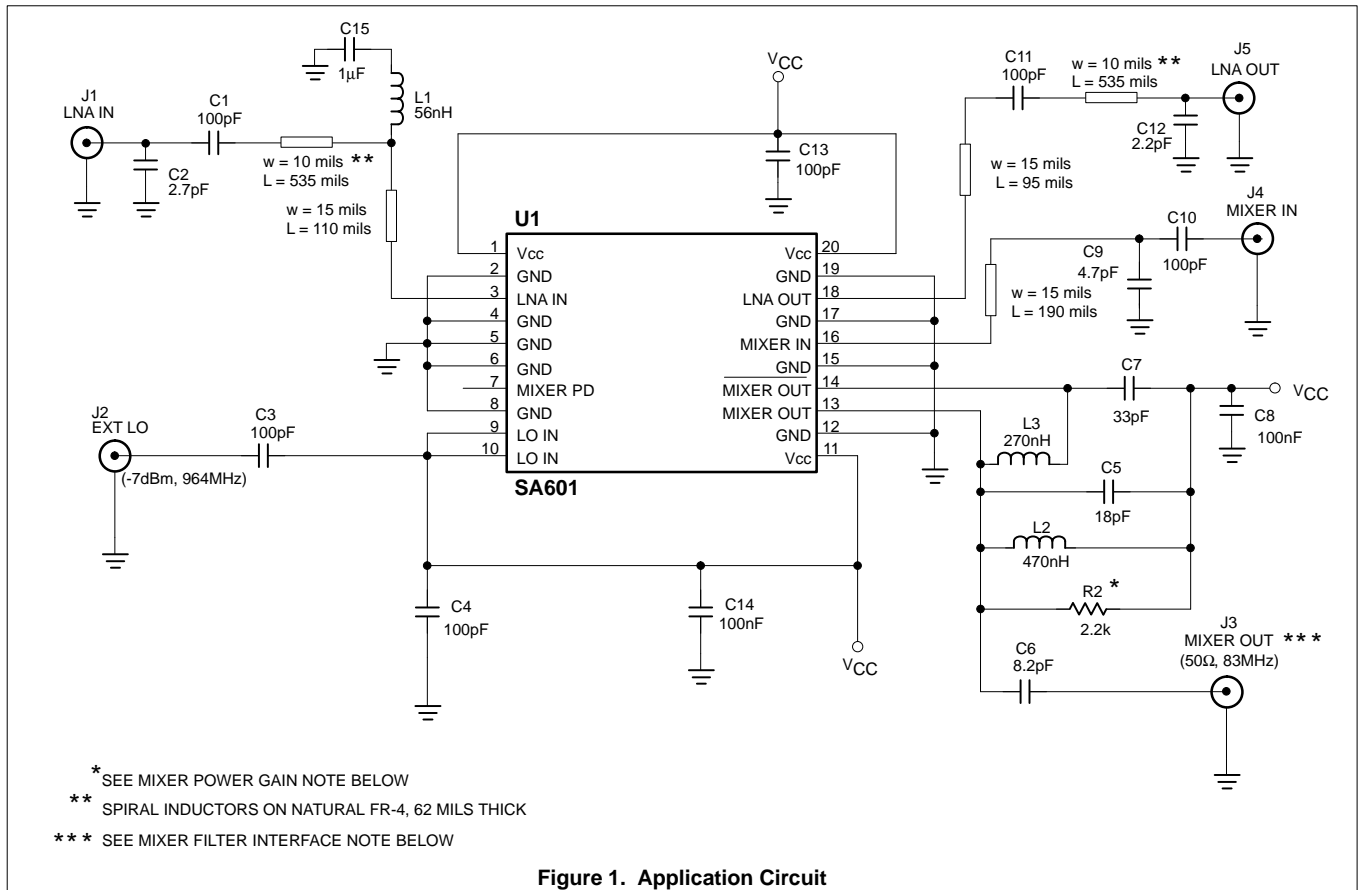

Figure 1. Application Circuit

CIRCUIT TECHNOLOGY

LNA

Impedance Match: Intrinsic return loss at the input and output ports is 7dB and 9dB, respectively. With no external matching, the associated LNA gain is ≈ 10 dB and the noise figure is ≈ 1.4 dB. However, the return loss can be improved at 881MHz using suggested L/C elements (Figure 1) as the LNA is unconditionally stable.

Noise Match: The LNA achieves 1.6dB noise figure at 881MHz when $S_{11} = -10$ dB. Further improvements in S_{11} will slightly decrease the NF and increase S_{21} .

Temperature Compensation: The LNA has a built-in temperature compensation scheme to reduce the gain drift to 0.003dB/ $^{\circ}$ C from -40° C to $+85^{\circ}$ C.

Supply Voltage Compensation: Unique circuitry provides gain stabilization over wide supply voltage range. The gain changes no more than 0.5dB when V_{CC} increases from 3V to 5V.

LO Drive Level: Resistor R1 can be replaced by an inductor of 4.7nH and C13 should be adjusted to achieve a good return loss at the LO port. Under this condition, the mixer will operate with less than -10dBm LO drive.

IP3 Performance: C9 between Pin 16 and ground can be removed to introduce 3dB mismatch loss, while improving the IP3 to +3dBm. The associated noise figure is 11dB.

Mixer

Input Match: The mixer is configured for maximum gain and best noise figure. The user needs to supply L/C elements to achieve this performance.

Power Gain: The gain can be increased by approximately 1.5dB by placing R2 across C7, instead of C5.

Power Down: The mixer can be disabled by connecting Pin 7 to ground. When the mixer is disabled, 3mA is saved.

Power Combining: The mixer output circuit features passive power combining (patent pending) to optimize conversion gain and noise figure performance without using extra DC current or degrading the IP3. For IF frequencies significantly different than 83MHz, the component values must be altered accordingly.

Filter Interface: For system integration where a high impedance filter of 1k Ω is to be cascaded at the mixer IF output, capacitors C5 and C6 need to be changed to 27pF and 1000pF, respectively.

Low voltage LNA and mixer - 1GHz

SA601

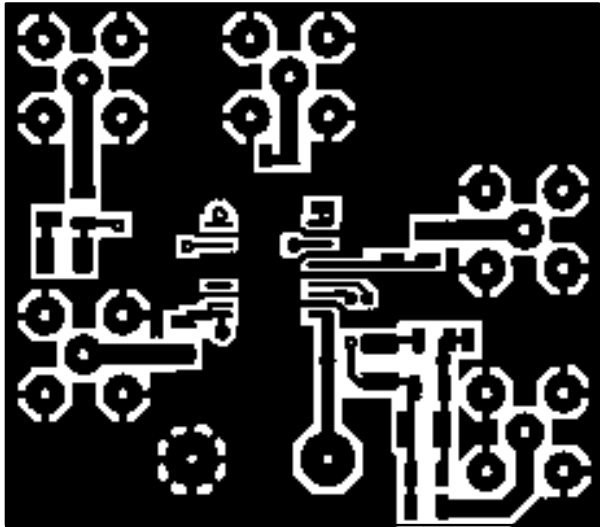

Top View

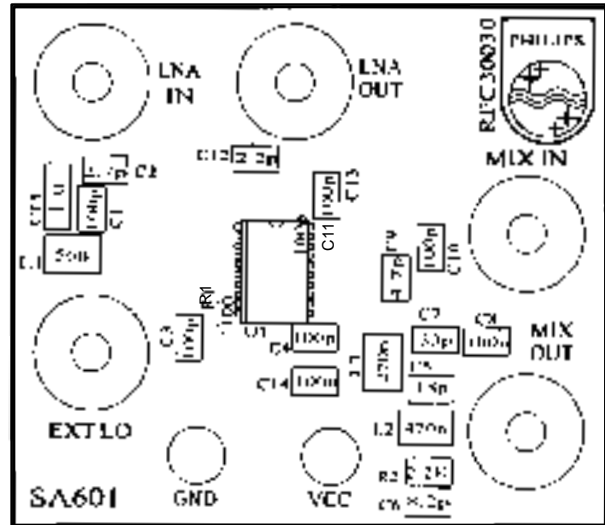

Silk Screen

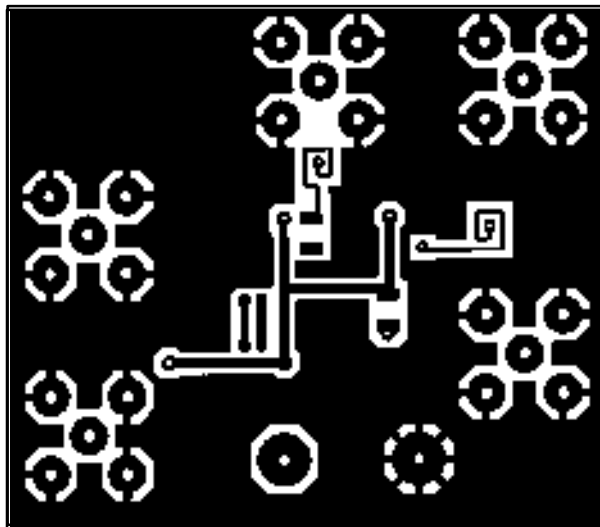

Bottom View

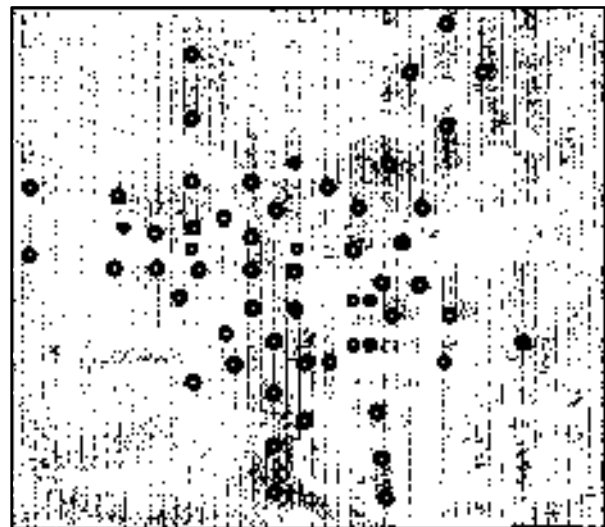

Via Layer

Figure 2. SA601 Demoboard Layout (Not Actual Size)

Low voltage LNA and mixer - 1GHz

SA601

TYPICAL PERFORMANCE CHARACTERISTICS

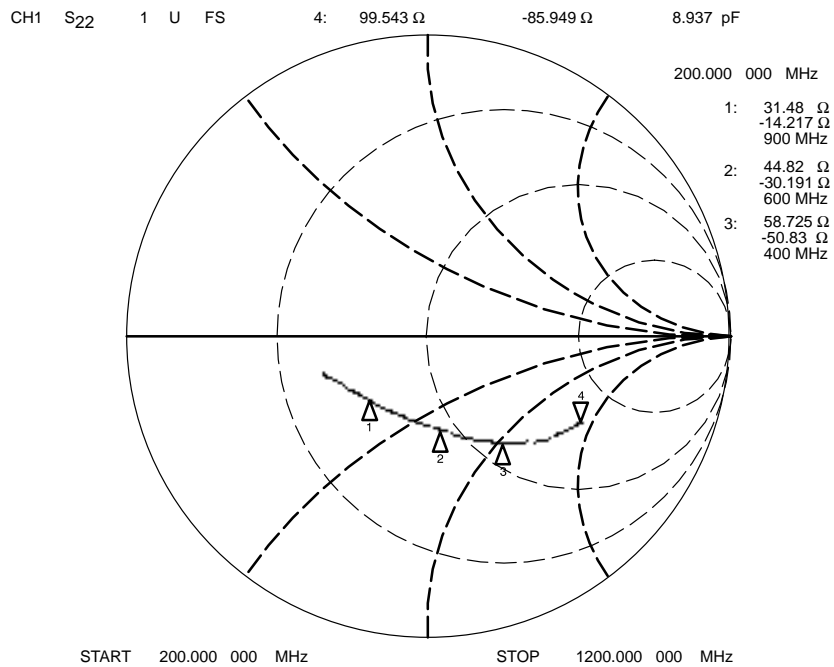
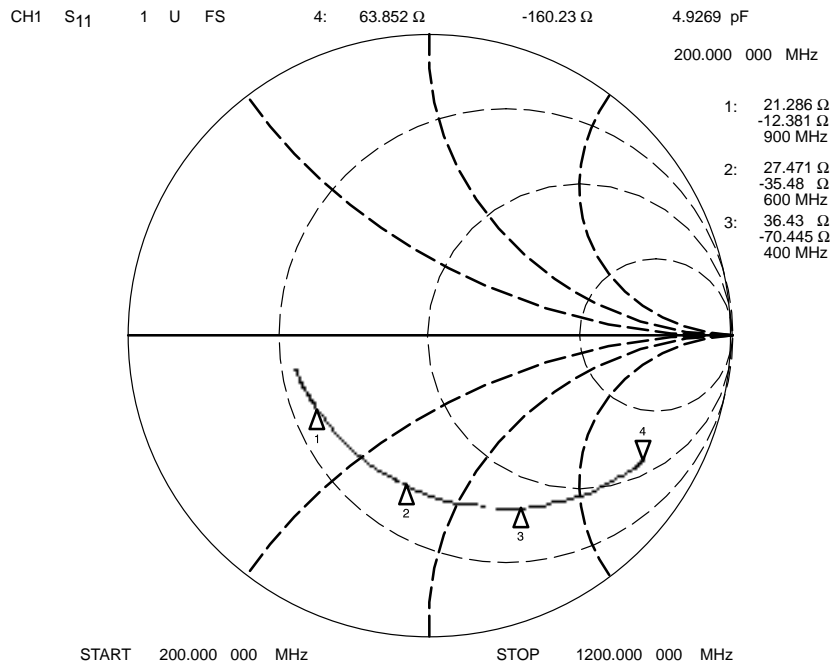

Figure 3. LNA Input and Output Match (at Device Pin)

Low voltage LNA and mixer - 1GHz

SA601

TYPICAL PERFORMANCE CHARACTERISTICS (Continued)

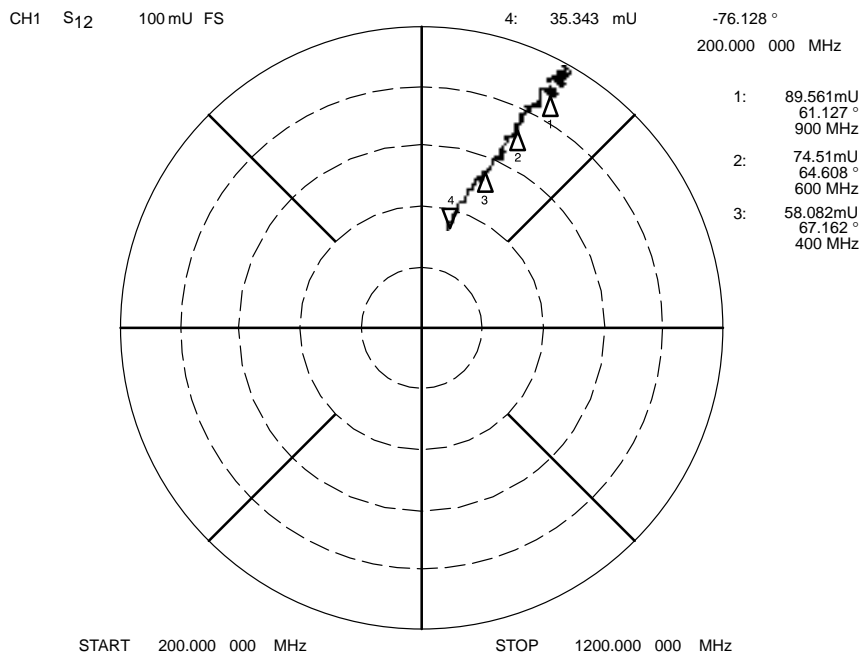
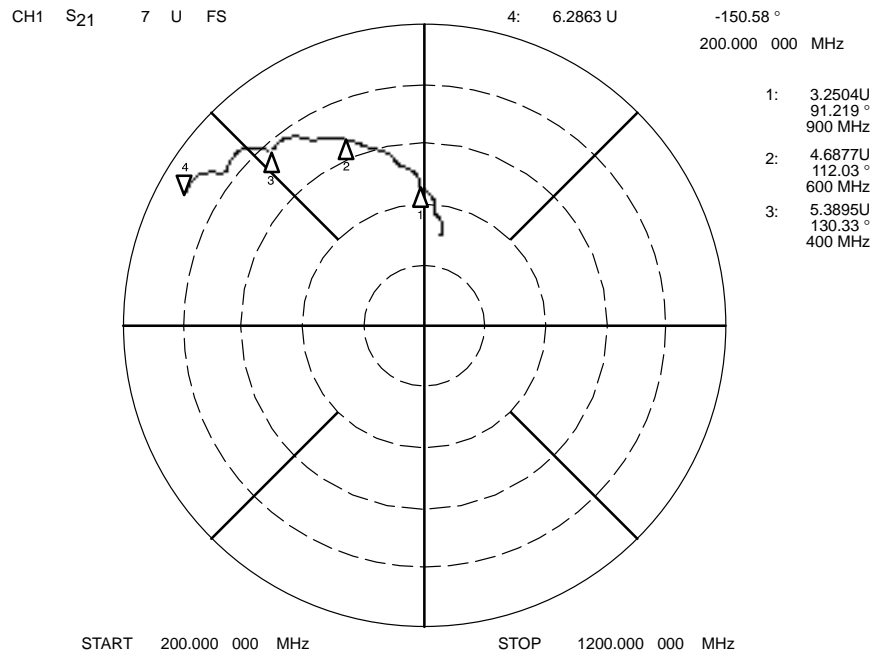

Figure 4. LNA Transmission and Isolation Characteristics (at Device Pin)

Low voltage LNA and mixer - 1GHz

SA601

TYPICAL PERFORMANCE CHARACTERISTICS (Continued)

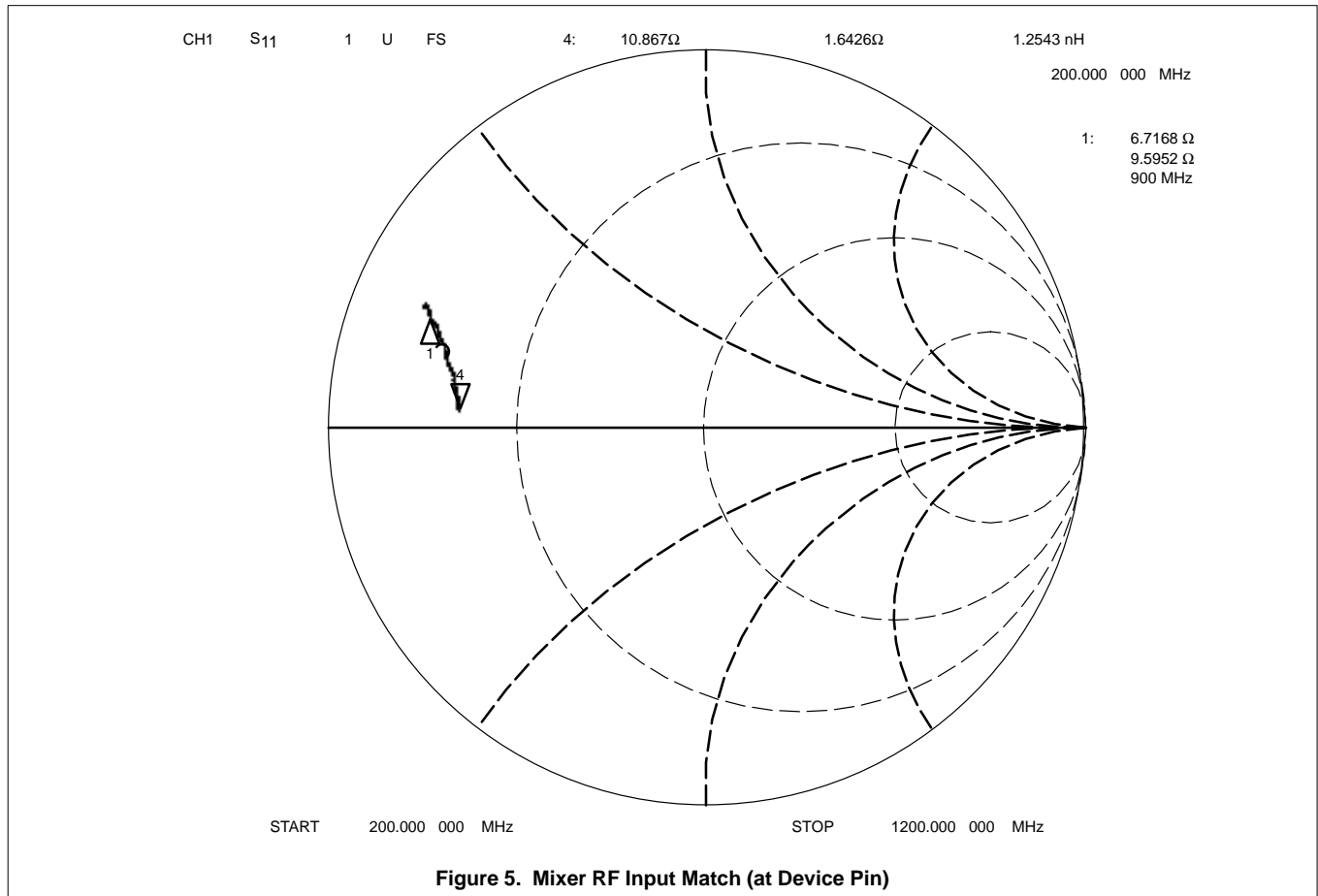

Figure 5. Mixer RF Input Match (at Device Pin)

Table 1. Typical LNA and Mixer S-Parameters

f	LNA				Mixer
	S ₁₁	S ₂₂	S ₂₁	S ₁₂	S ₁₁
200MHz	63.852Ω - j 160.23Ω	99.543Ω - j 85.949Ω	6.2863U ∠ 150.58°	35.343mU ∠ 76.128°	10.867Ω + j 1.6426Ω
300MHz	44.879Ω - j 101.69Ω	73.387Ω - j 67.707Ω	5.8096U ∠ 140.47°	47.946mU ∠ 71.169°	10.4Ω + j 3.4609Ω
400MHz	36.43Ω - j 70.445Ω	58.725Ω - j 50.83Ω	5.3895U ∠ 130.33°	58.082mU ∠ 67.162°	10.067Ω + j 4.897Ω
500MHz	30.395Ω - j 48.393Ω	49.928Ω - j 38.813Ω	5.0428U ∠ 120.5°	66.44mU ∠ 66.388°	9.394Ω + j 6.0142Ω
600MHz	27.471Ω - j 35.48Ω	44.82Ω - j 30.191Ω	4.6877U ∠ 112.03°	74.51mU ∠ 64.608°	8.8945Ω + j 7.2227Ω
700MHz	24.428Ω - j 25Ω	39.268Ω - j 24.502Ω	4.2409U ∠ 104.44°	82.235mU ∠ 65.002°	8.1353Ω + j 8.1597Ω
800MHz	22.434Ω - j 17.255Ω	34.664Ω - j 18.59Ω	3.7491U ∠ 97.765°	86.582mU ∠ 62.743°	7.976Ω + j 9.1958Ω
900MHz	21.286Ω - j 12.381Ω	31.48Ω - j 14.217Ω	3.2504U ∠ 91.219°	89.561mU ∠ 61.127°	6.7168Ω + j 9.5952Ω
1000MHz	20.261Ω - j 8.7109Ω	27.887Ω - j 10.77Ω	2.8785U ∠ 84.957°	95.135mU ∠ 60.539°	6.2393Ω + j 10.271Ω
1100MHz	19.718Ω - j 6.252Ω	25.741Ω - j 8.2607Ω	2.5752U ∠ 82.893°	97.348mU ∠ 62.202°	6.0791Ω + j 10.571Ω
1200MHz	19.101Ω - j 4.9316Ω	23.584Ω - j 6.2715Ω	2.1386U ∠ 80.257°	96.558mU ∠ 61.563°	5.8185Ω + j 10.288Ω

Low voltage LNA and mixer - 1GHz

SA601

TYPICAL PERFORMANCE CHARACTERISTICS (Continued)

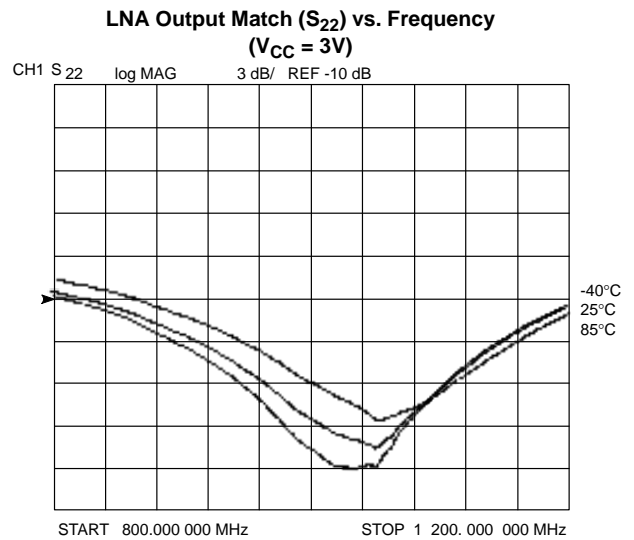
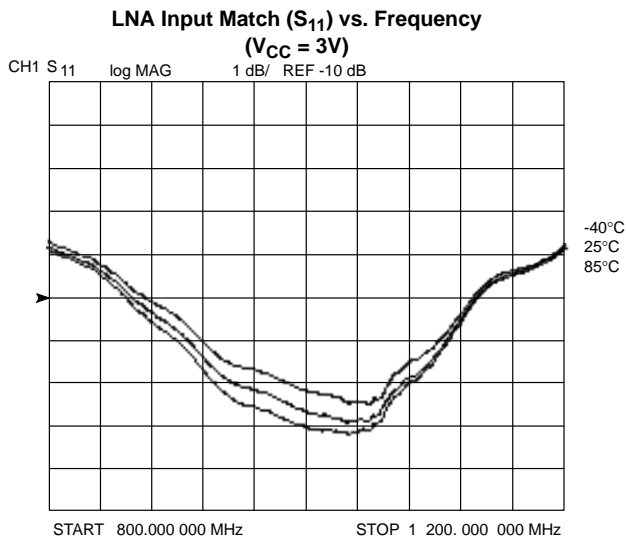
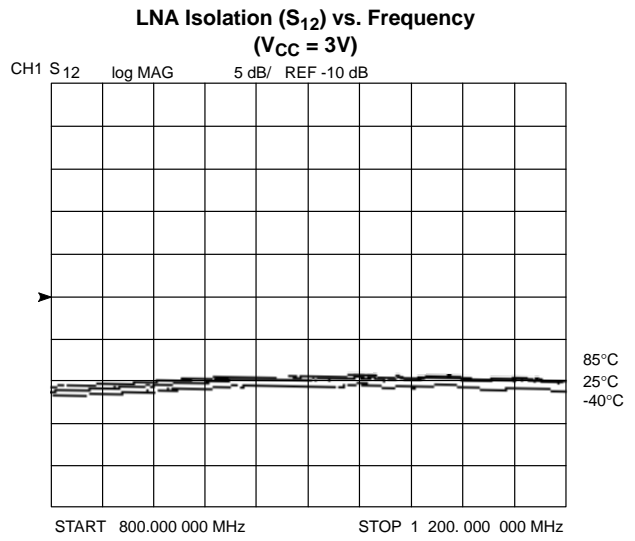
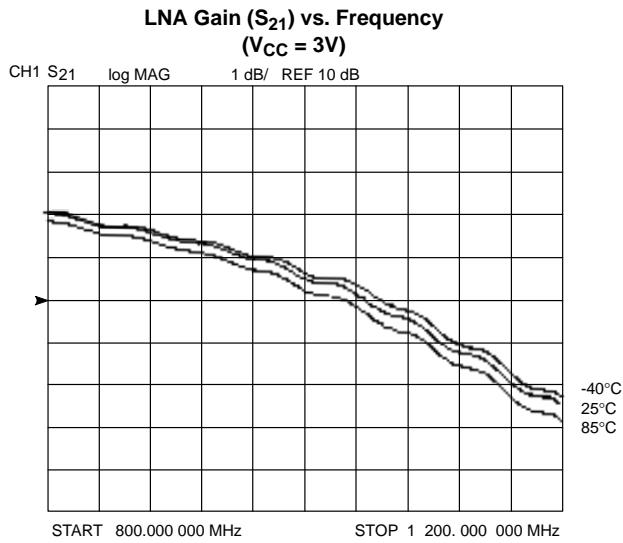
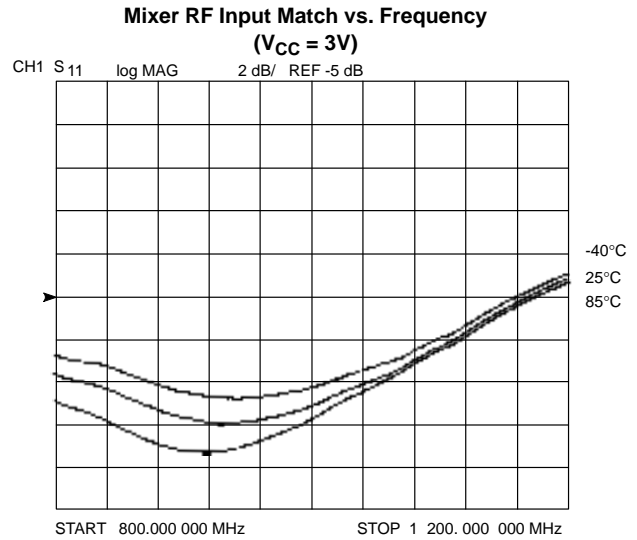
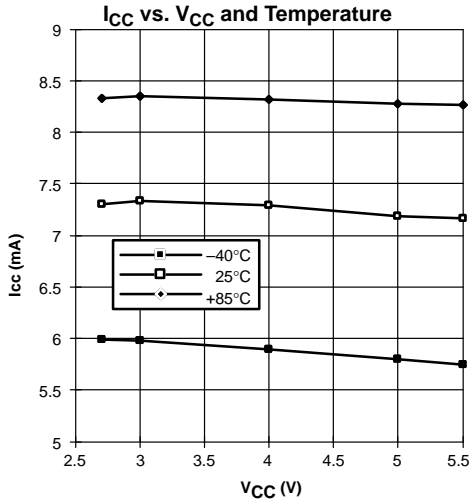

Low voltage LNA and mixer - 1GHz

SA601

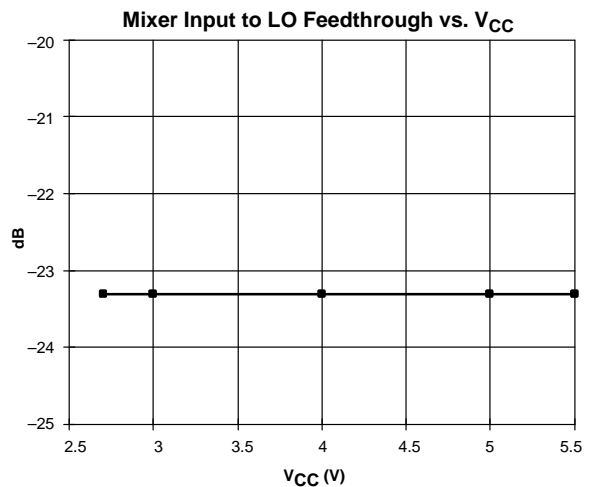
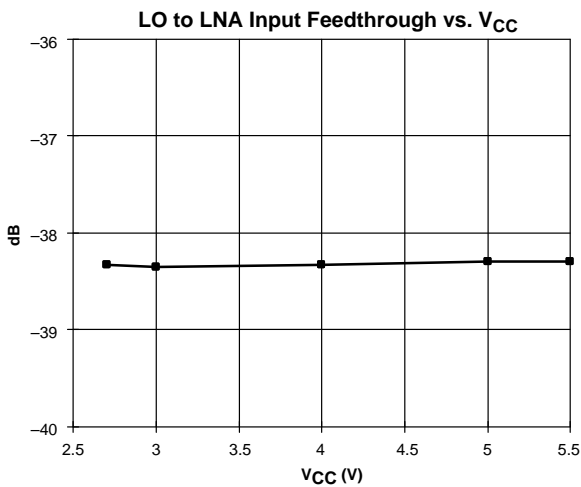
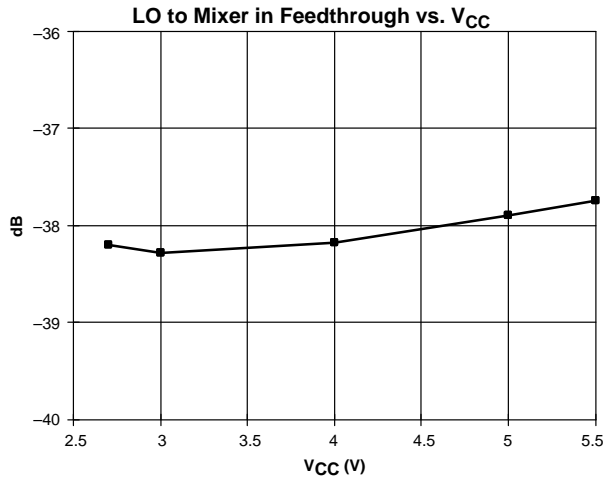
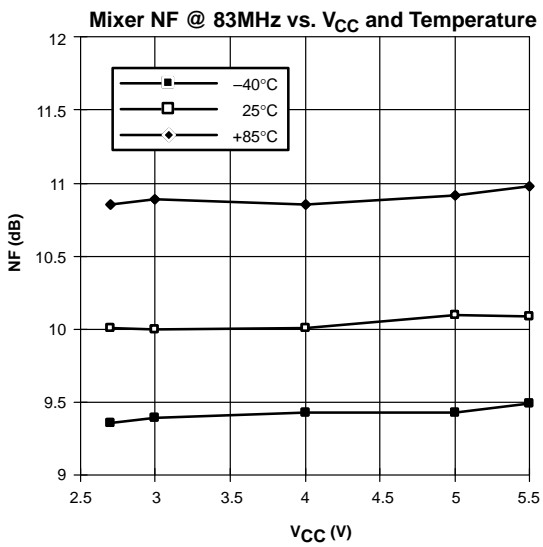
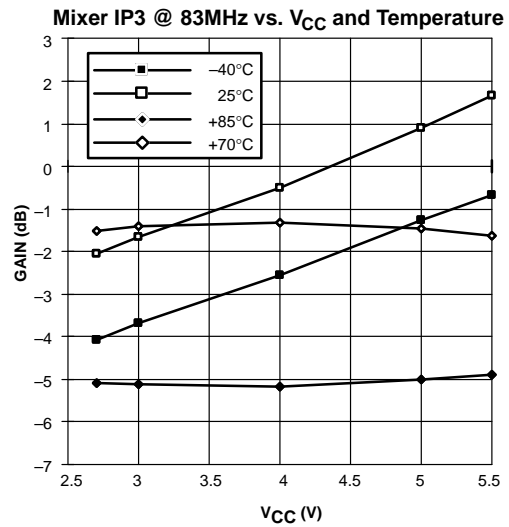
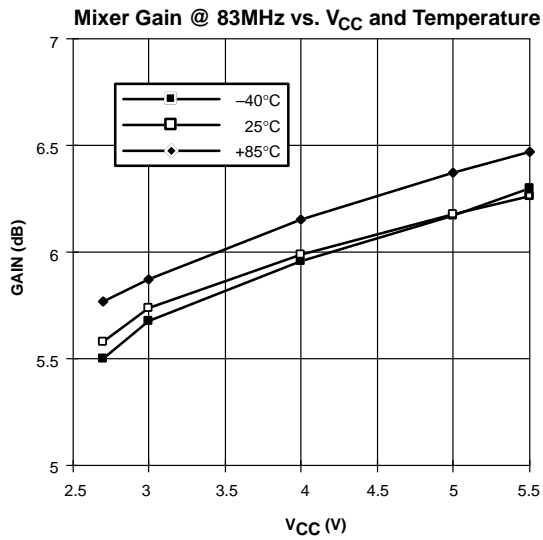

Low voltage LNA and mixer - 1GHz

SA601

